

# MULTI 2

623



## MANUALE DI ISTRUZIONE E INSTALLAZIONE INSTRUCTION AND INSTALLATION MANUAL

Quadro elettronico avviamento diretto 2 motori per acque pulite e reflue con sezionatore blocca porta.

Direct starting electronic control panel 2 motors for clean water and sewage with general disconnecting switch with door lock.

1. Istruzioni generali per l'installazione.....	3
2. Avvertenze.....	3
3. Schemi di collegamento	
3.1 Schema di collegamento 658.623.....	4
3.2 Schema di collegamento 659.626.....	5
4. Esempi applicativi.....	6
5. Programmazione	
5.1 Impostazione DIP-SWITCH.....	7
5.2 Regolazione trimmer.....	7
6. Funzionamento generale del quadro	
6.1 Funzionamento generale.....	8
6.2 Applicazione booster di pressione.....	9
6.3 Applicazione acque pulite.....	9
6.4 Applicazione acque reflue.....	9
7. Ricerca guasti e soluzioni proposte.....	10
8. Smaltimento di vecchi apparecchi elettrici ed elettronici.....	21
9. Dichiarazione di conformità.....	21

Assicurarsi che la linea sia protetta, secondo le normative, in funzione dell'applicazione. Accertarsi che la potenza e la corrente di targa del motore rispecchino i limiti di impiego del quadro.

Installare il quadro in ambienti adatti al suo grado di protezione IP65. Per il fissaggio dell'involucro, utilizzare le staffe per i box 03-04 e le apposite predisposizioni per i restanti box. Nell'effettuare il fissaggio dell'involucro fare molta attenzione a non toccare o danneggiare i vari componenti. Eliminare qualsiasi tipo di impurità metallica e/o plastica che dovesse casualmente cadere all'interno dell'involucro (viti, rondelle, polvere...). Effettuare i collegamenti elettrici rispettando gli schemi di collegamento.

Nel fissare i cavi sulle morsettiere, adoperare attrezzi di giuste misure e dimensioni evitando di danneggiare i morsetti metallici e le relative sedi. Prima di qualsiasi operazione da effettuare all'interno, escludere l'alimentazione generale.





Le operazioni di regolazione all'interno del quadro devono essere svolte da personale qualificato. In caso di intervento delle protezioni verificarne la causa prima del ripristino.

In caso di necessità sostituire i vari componenti solo con altri aventi le stesse caratteristiche e portate di quelli originali.

**È compito dell'installatore verificare l'apparecchiatura dopo l'installazione nonostante questa sia già stata sottoposta regolarmente a prove dal costruttore.**

**Il costruttore declina ogni responsabilità per sinistri a cose o persone dovuti a manomissioni delle apparecchiature da parte di personale non autorizzato o da carenze nella manutenzione e riparazione.**

## 2. AVVERTENZE

	<p><b>SCOSSE ELETTRICHE</b></p> <p>Rischio di scosse elettriche se non si osserva quanto prescritto.</p>
	<p><b>PERICOLO</b></p> <p>Rischio di lesioni personali e materiali se non si osserva quanto prescritto.</p>
	<p><b>AVVERTENZA</b></p> <p>Prima di installare e utilizzare questo prodotto leggere attentamente questo manuale nella sua totalità. L'installazione e la manutenzione devono essere realizzate da personale qualificato e secondo le normative in vigore. Il costruttore non è responsabile di danni causati per un uso improprio o proibito di questo dispositivo e nemmeno di danni causati da una non corretta installazione e manutenzione dello stesso. L'utilizzo di pezzi non originali, la manipolazione o l'uso improprio annulleranno la garanzia.</p>
	<p><b>AVVERTENZA</b></p> <p>Assicurarsi che la potenza del motore sia dentro i limiti del quadro. Installare il dispositivo solo in ambienti adeguati al suo grado di protezione IP 65. Nel caso di operazioni dentro il quadro utilizzare strumenti adeguati per evitare di danneggiare i morsetti.</p>
	<p><b>PERICOLO</b></p> <p>Prima di realizzare qualsiasi intervento assicurarsi che il quadro sia collegato all'alimentazione. Non compiere nessuna operazione quando il quadro è aperto. Il dispositivo deve essere collegato a una messa a terra efficiente. Per fissare la carcassa utilizzare i fori appropriati presenti nel fondo per non danneggiare i componenti interni e eliminare qualsiasi scarto di lavoro dentro il quadro. Nel caso di intervento delle protezioni verificarne la causa prima del ripristino.</p>

### 3. SCHEMI DI COLLEGAMENTO

#### 3.1 Schema di collegamento 658.623

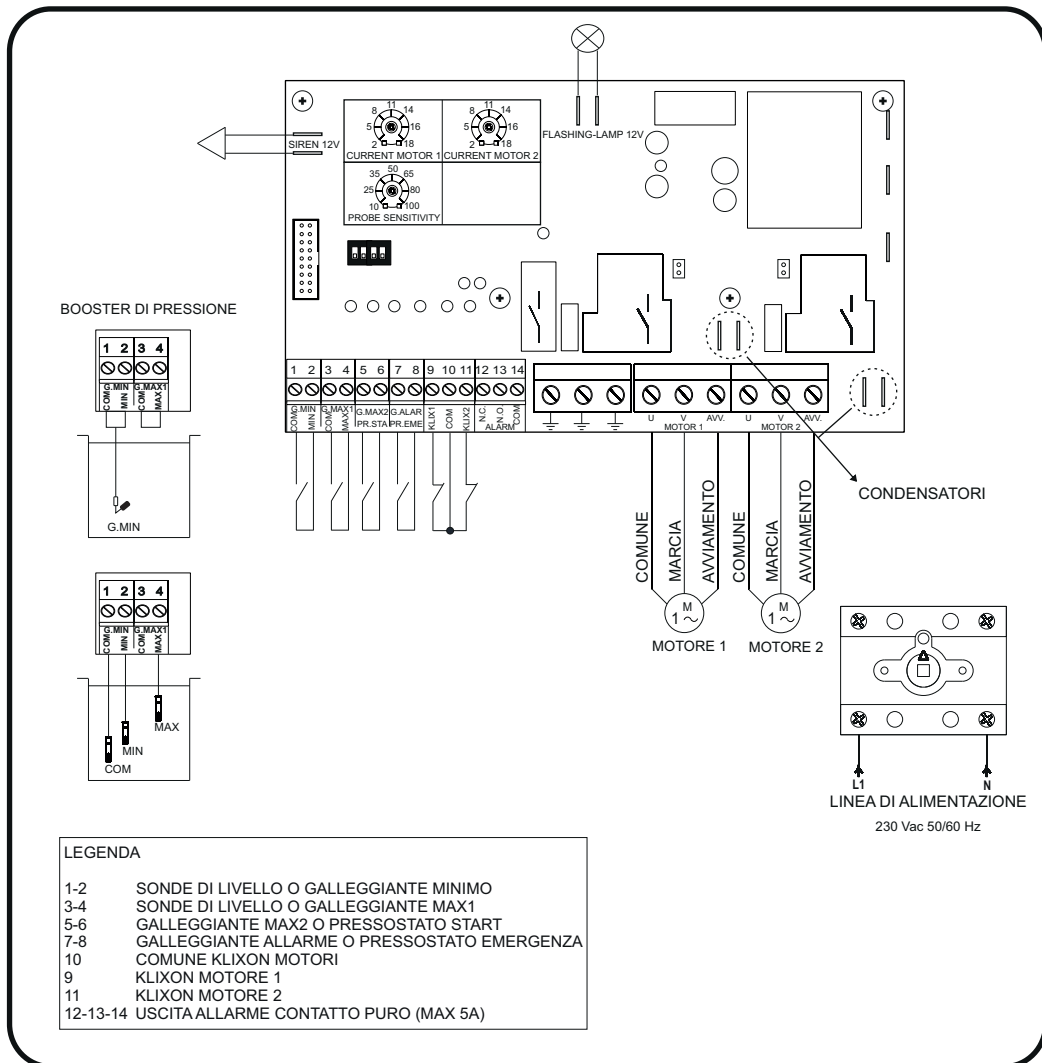

<p>Max 10 mm<sup>2</sup> ⊕ (M4) 10 mm      0,8Nm</p>	<p>Max 4 mm<sup>2</sup> ⊕ (M3) 9,8 mm      0,5Nm</p>	<p>Max 2.5 mm<sup>2</sup> ⊖ (M3) 8,3 mm      0,5Nm</p>

3.2 Schema di collegamento 659.626

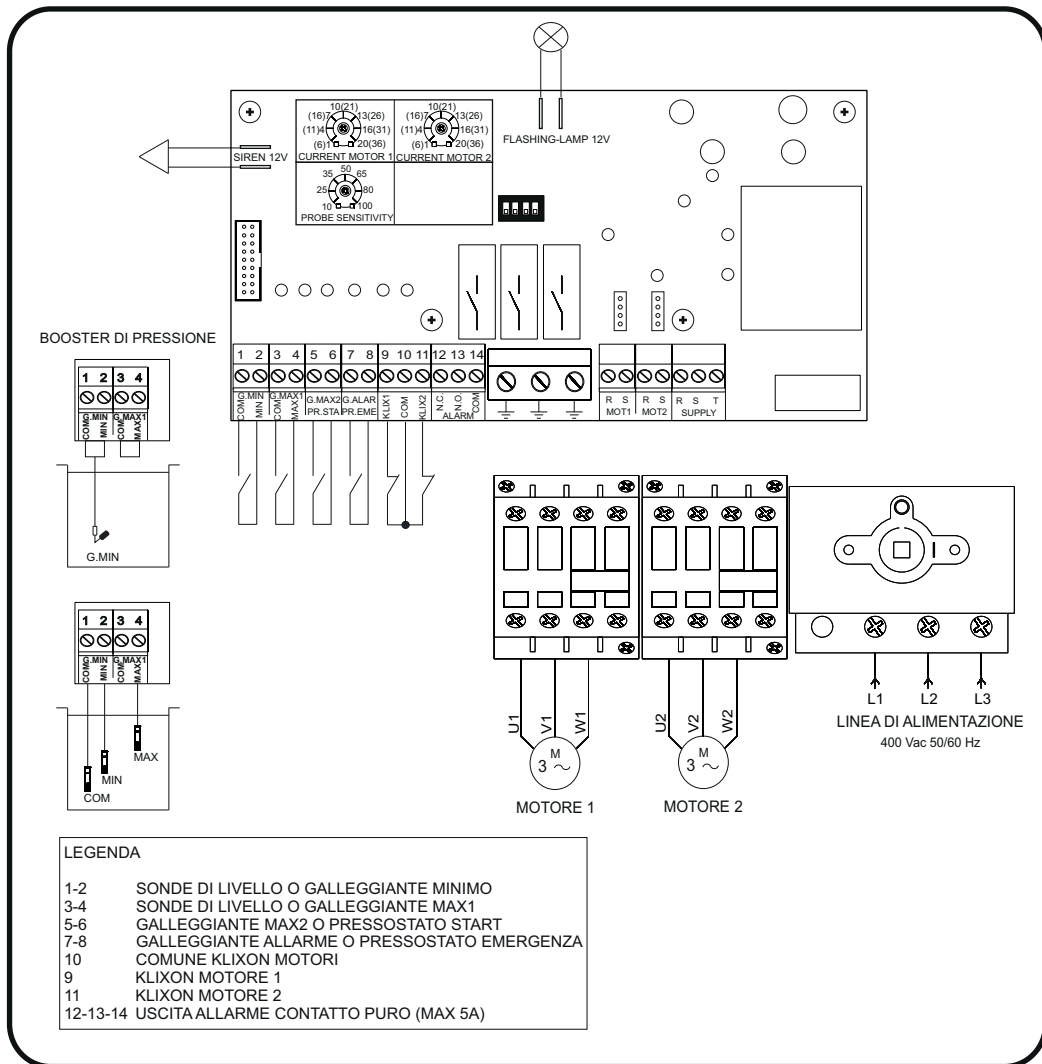

- LEGENDA**
- 1-2 SONDE DI LIVELLO O GALLEGGIANTE MINIMO
  - 3-4 SONDE DI LIVELLO O GALLEGGIANTE MAX1
  - 5-6 GALLEGGIANTE MAX2 O PRESSOSTATO START
  - 7-8 GALLEGGIANTE ALLARME O PRESSOSTATO EMERGENZA
  - 10 COMUNE KLIXON MOTORI
  - 9 KLIXON MOTORE 1
  - 11 KLIXON MOTORE 2
  - 12-13-14 USCITA ALLARME CONTATTO PURO (MAX 5A)

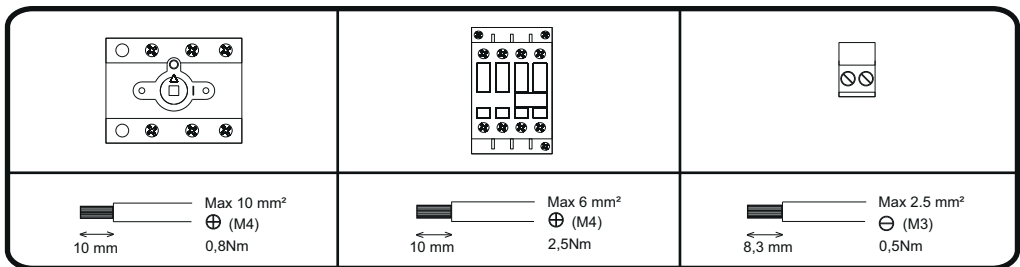



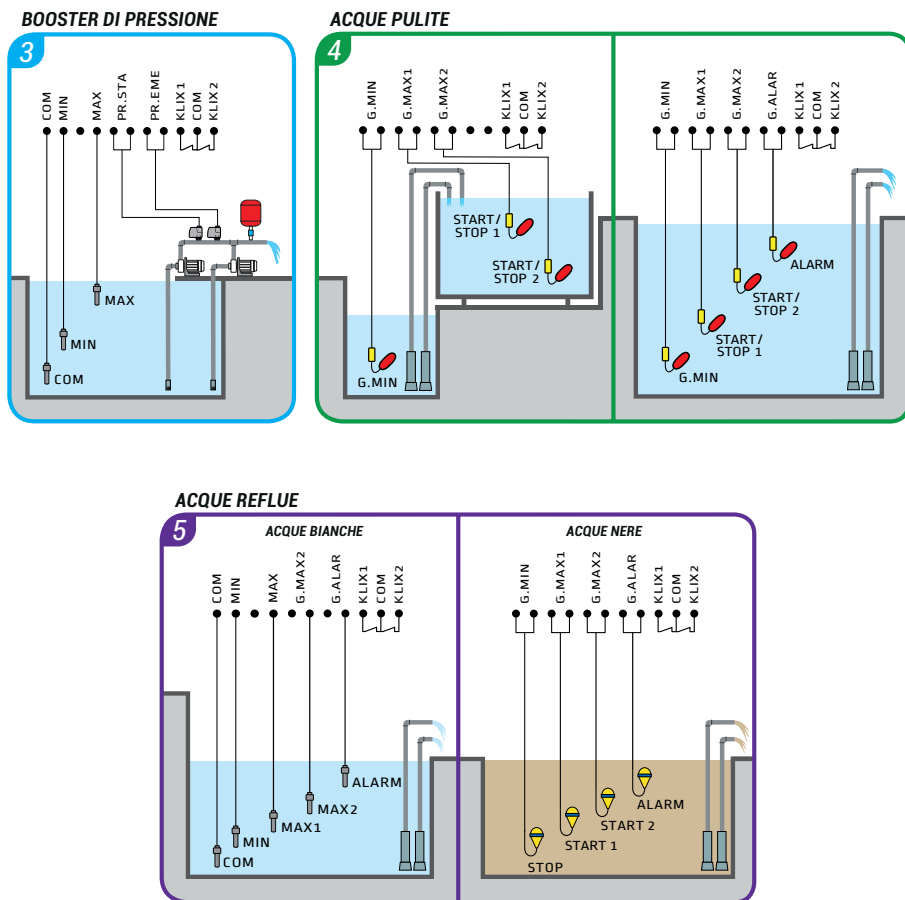

## 4. ESEMPI APPLICATIVI

Di seguito vengono illustrati alcuni esempi pratici delle applicazioni che è possibile realizzare con il quadro **MULTI2**.



### LEGENDA COMPONENTI

-  Pressostato
-  Galleggiante per acque pulite
-  Galleggiante per acque reflue
-  Sonda di livello

### 5.1 Impostazioni DIP-SWITCH

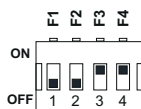
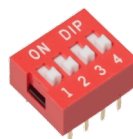

CONFIGURAZIONE DI DEFAULT

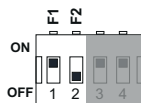

APPLICAZIONE BOOSTER DI PRESSIONE

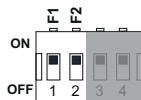

APPLICAZIONE ACQUE PULITE

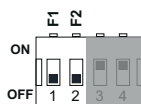

APPLICAZIONE ACQUE REFLUE



ALTERNANZA DEI MOTORI

Attiva

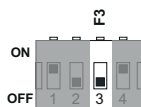

Disattiva

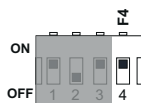

PROTEZIONE MINIMA E MASSIMA TENSIONE

Attiva

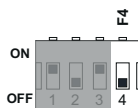

Disattiva

I valori di **minima** e **massima tensione** sono tarati ad un valore fisso, nella versione monofase 185V e 255V mentre nella versione trifase 345V e 440V.

### 5.2 Regolazione trimmer

#### VERSIONE MONOFASE

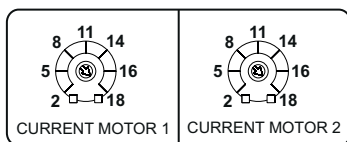

SA674.00

#### VERSIONE TRIFASE

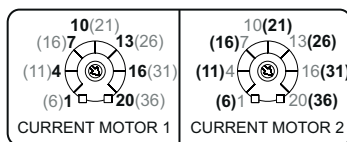

SA677.02

SA677.03  
SA677.04



Con i trimmer **CURRENT MOTOR 1** e **2** è possibile regolare la corrente massima di sovraccarico dei motori.

Per effettuare una buona calibrazione è raccomandabile ruotare il trimmer fino al valore di fondo scala e successivamente, quando si avvia il motore, ruotarlo in senso antiorario fino ad individuare la corrente di assorbimento del motore (il led rosso **PROTECTION** si accende) e poi aumentare la regolazione di un 20%.

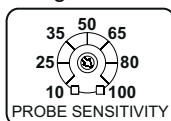

Mediante questo trimmer è possibile impostare la sensibilità della conduttività tra le sonde di livello sugli ingressi **G.MIN**, **G.MAX1**, **G.MAX2** e **ALL**. L'intervallo di regolazione va da 10 a 100 Kohm.

## 6. FUNZIONAMENTO GENERALE DEL QUADRO

### 6.1 Funzionamento generale

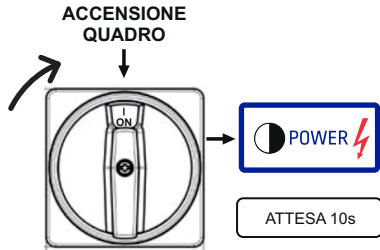

PRESENZA RETE



VALORE DI TENSIONE MISURATO È AL DI FUORI DELLA SOGLIA CONSENTITA



MANCANZA O ERRATA SEQUENZA FASE



INDICA CHE I MOTORI 1 E 2 SONO IN FUNZIONE



INDICA CHE I MOTORI 1 E 2 SONO SPENTI



INDICA UN ALLARME DI SOVRACCARICO DEI MOTORI CHE NE CAUSA LO SPEGNIMENTO



INDICA UN ALLARME DI INTERVENTO DEL KLIXON DEI MOTORI CHE NE CAUSA LO SPEGNIMENTO



SERVE A TACITARE L'USCITA SIRENE IN PRESENZA DI QUALSIASI ALLARME



**FUNZIONAMENTO MANUALE:** SI ATTIVA DALLO STATO **STOP** TENENDO PREMUTO IL PULSANTE. IN QUESTA CONDIZIONE IL QUADRO AVVIA IL MOTORE FINO AL SUO RILASCIO ESCLUDENDO IL CONTROLLO SULL'AUTOMATICO. RILASCIANDO IL PULSANTE SI RITORNA ALLO STATO **STOP**.



**FUNZIONAMENTO AUTOMATICO:** SI ATTIVA DALLO STATO **STOP** PREMENDO IL PULSANTE. IN QUESTA CONDIZIONE IL QUADRO FUNZIONERÀ SECONDO L'APPLICAZIONE IMPOSTATA.



**FUNZIONAMENTO STOP:** IN QUESTA CONDIZIONE IL QUADRO NON AVVIA IL MOTORE.

**N.B.: TUTTI GLI ALLARMI VENGONO RIPRISTINATI AUTOMATICAMENTE AD ECCEZIONE DELLA SOVRACCORRENTE MOTORE CHE SI RESETTA PREMENDO PER 2s IL PULSANTE**

LEGENDA  
LED

● Spento

☀️ Acceso

◐ Lampeggiante

⚡ Lampeggiante veloce  
<0,5s



## 6.2 Applicazione booster di pressione

FUNCTION



PRESSOSTATO START ON, VIENE ABILITATO SOLO UN MOTORE



PRESSOSTATO EMERGENZA ON, VENGONO ABILITATI ENTRAMBI I MOTORI

ALARM



MANCANZA ACQUA (LIVELLO MINIMO SCOPERTO) VENGONO DISABILITATI ENTRAMBI I MOTORI



ATTESA RIEMPIMENTO, RESTANO DISABILITATI ENTRAMBI I MOTORI

**N.B.:** I MOTORI SI AVVIANO SOLO SE SI TROVANO NEL FUNZIONAMENTO AUTOMATICO E SI ARRESTANO QUANDO IL PRESSOSTATO (START O EMERGENZA) DEL RISPETTIVO MOTORE È OFF OPPURE SI PRESENTA UNA CONDIZIONE DI MANCANZA ACQUA

## 6.3 Applicazione acque pulite

FUNCTION



GALLEGGIANTE MAX 1 ON, VIENE ABILITATO SOLO UN MOTORE



GALLEGGIANTE MAX 2 ON, VENGONO ABILITATI ENTRAMBI I MOTORI

ALARM



GALLEGGIANTE ALLARME ON, VENGONO ABILITATI ENTRAMBI I MOTORI E LE USCITE ALLARME (LAMPEGGIANTE, SIRENA E CONTATTO PULITO)

**N.B.:** I MOTORI SI AVVIANO SOLO SE SI TROVANO NEL FUNZIONAMENTO AUTOMATICO E SI ARRESTANO QUANDO IL GALLEGGIANTE (MAX 1 O MAX 2) DEL RISPETTIVO MOTORE È OFF OPPURE IL GALLEGGIANTE MIN È OFF

## 6.4 Applicazione acque reflue

FUNCTION



GALLEGGIANTE MAX 1 ON, VIENE ABILITATO IL PRIMO MOTORE



GALLEGGIANTE MAX 2 ON, VENGONO ABILITATI ENTRAMBI I MOTORI

ALARM



GALLEGGIANTE ALLARME ON, VENGONO ABILITATI ENTRAMBI I MOTORI E LE USCITE ALLARME (LAMPEGGIANTE, SIRENA E CONTATTO PULITO).

**N.B.:** I MOTORI SI AVVIANO SOLO SE SI TROVANO NEL FUNZIONAMENTO AUTOMATICO, E SI ARRESTANO SOLO QUANDO IL GALLEGGIANTE MIN È OFF

## 7. RICERCA GUASTI E SOLUZIONI

PROBLEMI COMUNI	POSSIBILI CAUSE	SOLUZIONI
Nessun led acceso	Alimentazione di rete Off	Alimentare il quadro rispettando la tensione in ingresso
	Sezionatore generale su 0	Posizionare il sezionatore su 1
	Cavetto flat all'interno del quadro scollegato	Collegare correttamente il cavetto flat dalla scheda madre al display
Allarme sovraccarico motore	Motore bloccato o danneggiato	Scollegare il motore e assicurarsi del suo corretto funzionamento
Modo BOOSTER: Led FUNCTION spento con pressione impianto bassa	Possibile guasto dei pressostati	Verificare la funzionalità dei pressostati e se necessario sostituirli
Modo ACQUE PULITE: Led FUNCTION spento con vasca piena	Possibile guasto dei galleggianti o cavo di collegamento interrotto	Verificare la funzionalità dei galleggianti e del cavo e se necessario sostituirli
Modo ACQUE REFLUE: Led FUNCTION spento con livello acqua alto	Possibile guasto dei galleggianti o cavo di collegamento interrotto	Verificare la funzionalità dei galleggianti e del cavo e se necessario sostituirli



1. General instructions for installing.....	13
2. Warnings.....	13
3. Wiring diagrams	
3.1 Wiring diagrams 658.623.....	14
3.2 Wiring diagrams 659.626.....	15
4. Application examples.....	16
5. Programming	
5.1 DIP-SWITCH setting.....	17
5.2 Trimmer adjustments.....	17
6. General functioning of the control panel	
6.1 General functioning.....	18
6.2 Application pressure booster.....	19
6.3 Application clean water.....	19
6.4 Application sewage.....	19
7. Troubleshooting and proposed solutions.....	20
8. Disposal of electrical & electronic equipment.....	21
9. Declaration of conformity.....	21

Make sure power supply is protected up to standard depending on application. The power of the motor has to be within the control panel's limits of use.

Install the control panel in an environment appropriate to its IP65 degree of protection. To fix the enclosure, use the brackets for the boxes 03-04 and the special predispositions for the remaining boxes. In order to fix the box, use the appropriate holes which are present or suggested on the bottom. Pay particular attention to not touching or damaging any components while fixing the box.

Eliminate whatever metal and/or plastic impurity which could happen to fall inside the box (screws, washers, dust...).

When connecting electric cables, follow the wiring diagrams.

When fixing the cables in the terminal board use tools of correct size to avoid damaging the metal feed clamps and their sockets.





Before acting upon anything inside, disconnect power supply. Regulation procedures must be carried out by qualified personnel. In case protections intervene verify the cause of the problem before resetting.

If necessary substitute the various components only with those having the same characteristics and components as the originals.

**It is the installer's duty to verify the device after the installation although it has already undergone regular testing by the manufacturer.**

**The manufacturer is released from all responsibilities for accidents to things or people, which derive from misuse of the devices by unauthorized personnel or from lack of maintenance and repair.**

2. WARNINGS

	<p><b>ELECTRIC SHOCKS</b></p> <p>Risk of electric shocks if not complied with the requirements.</p>
	<p><b>DANGER</b></p> <p>Risk of personal injury and property if not complied with the requirements.</p>
	<p><b>WARNING</b></p> <p>Before installing and using the product read this book in all its parts. Installation and maintenance must be performed by qualified personnel in accordance with current regulations. The manufacturer will not be held responsible for any damage caused by improper or prohibited use of this control panel and is not responsible for any damages caused by an incorrect installation or maintenance of the plant. The use of non-original spare parts, tempering or improper use, make the product warranty null.</p>
	<p><b>WARNING</b></p> <p>Be sure that the power of the motor is within the control panel range. Install the control panel in an environment appropriate to its IP 65 degree of protection. To operate inside the control panel use tools of correct size to avoid damaging the sockets.</p>
	<p><b>DANGER</b></p> <p>Before any intervention ensure that the control panel is disconnected from the electricity supply. Do not attempt operations when the control panel is open. The control panel must be connected to an efficient earthing system. In order to fix the box use the appropriate holes present on the bottom, don't damage internal components and eliminate any working debris inside the box. In the case of protections eliminate the cause of the malfunction before the restoration.</p>

### 3. WIRING DIAGRAM

#### 3.1 Wiring diagram 658.623

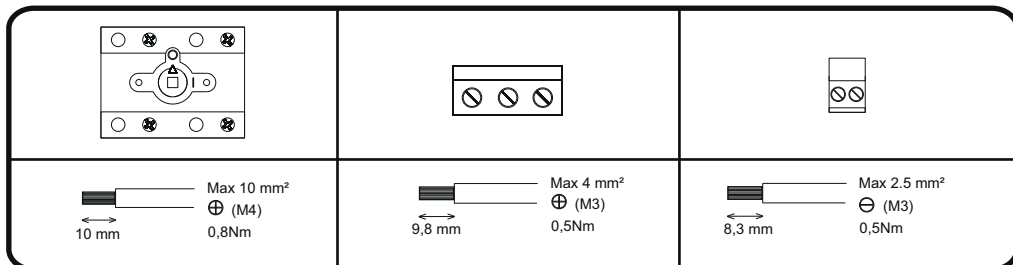
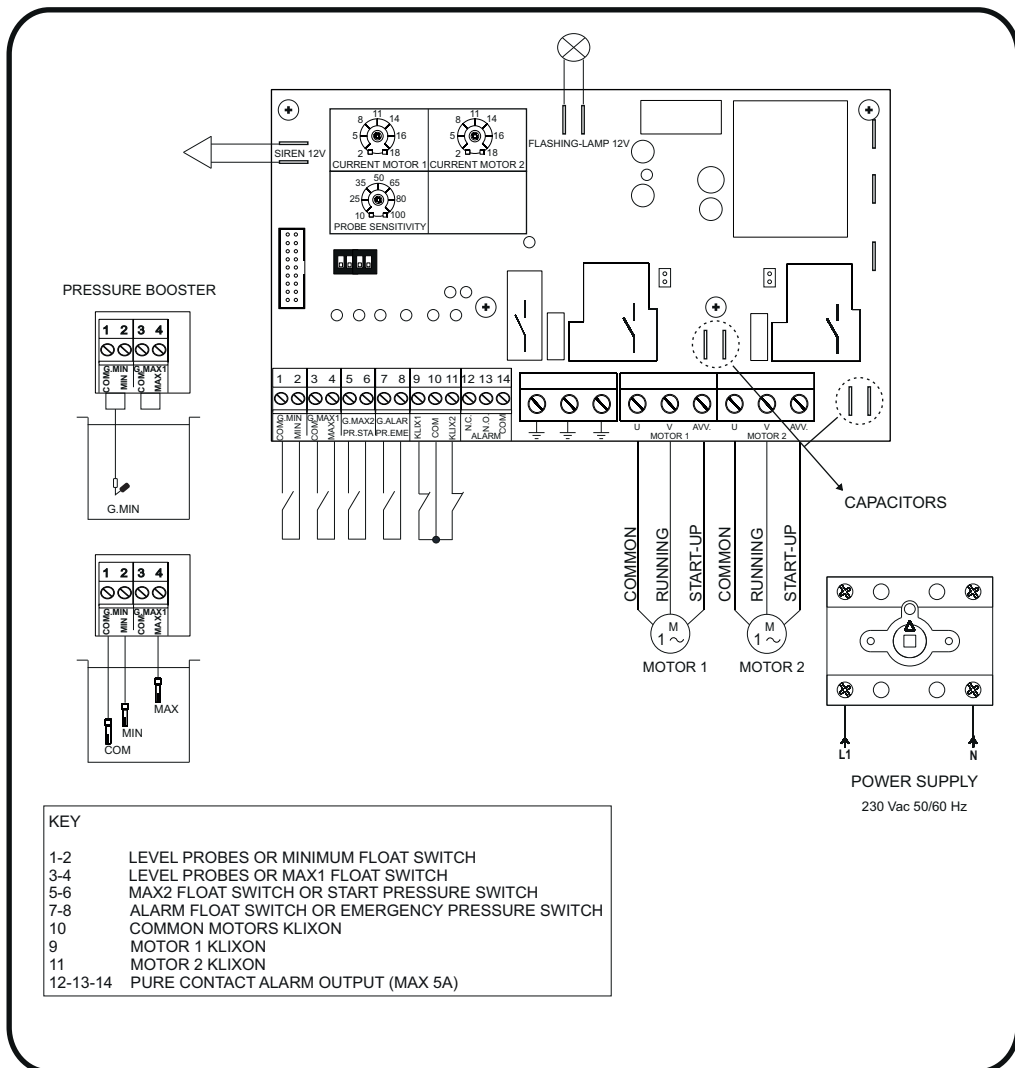

3.2 Wiring diagram 659.626

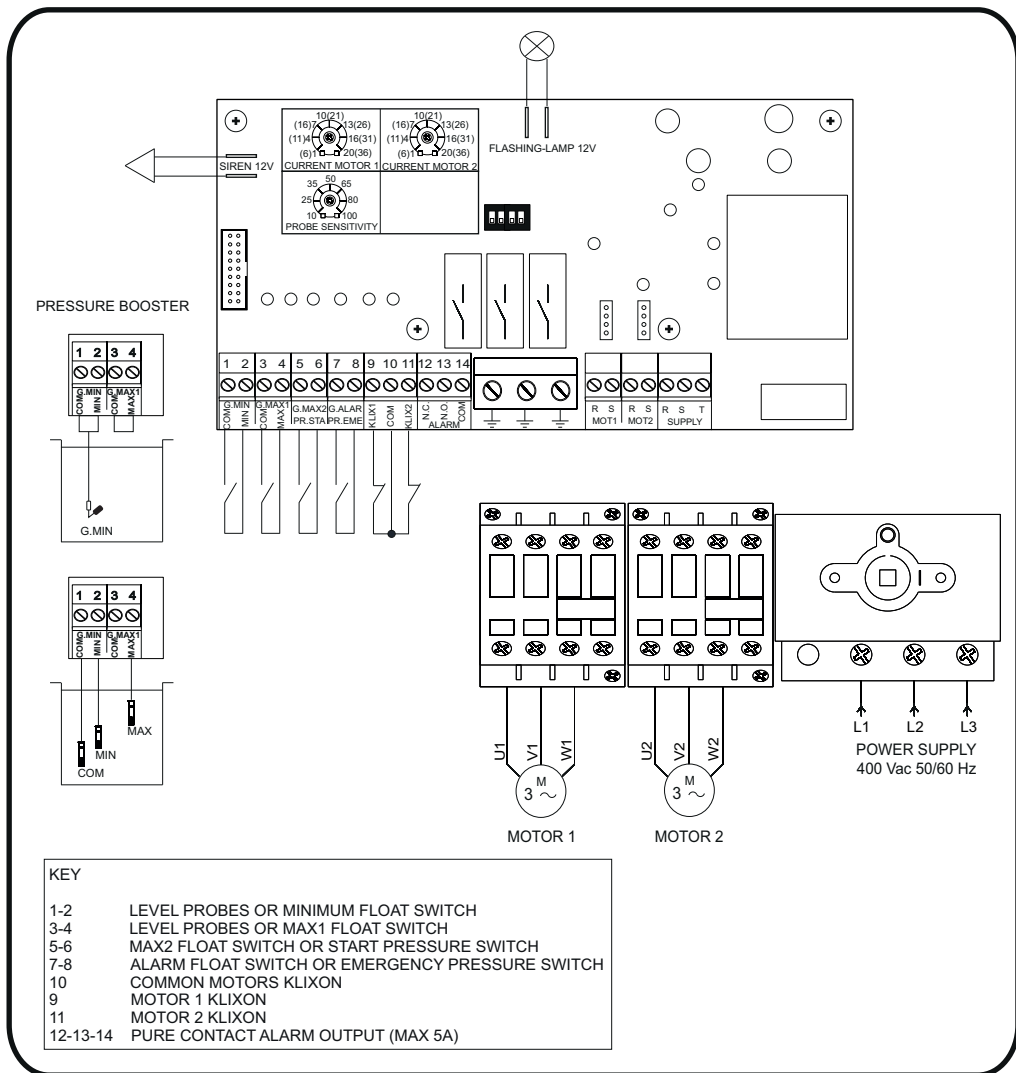

**KEY**

1-2	LEVEL PROBES OR MINIMUM FLOAT SWITCH
3-4	LEVEL PROBES OR MAX1 FLOAT SWITCH
5-6	MAX2 FLOAT SWITCH OR START PRESSURE SWITCH
7-8	ALARM FLOAT SWITCH OR EMERGENCY PRESSURE SWITCH
10	COMMON MOTORS KLIXON
9	MOTOR 1 KLIXON
11	MOTOR 2 KLIXON
12-13-14	PURE CONTACT ALARM OUTPUT (MAX 5A)

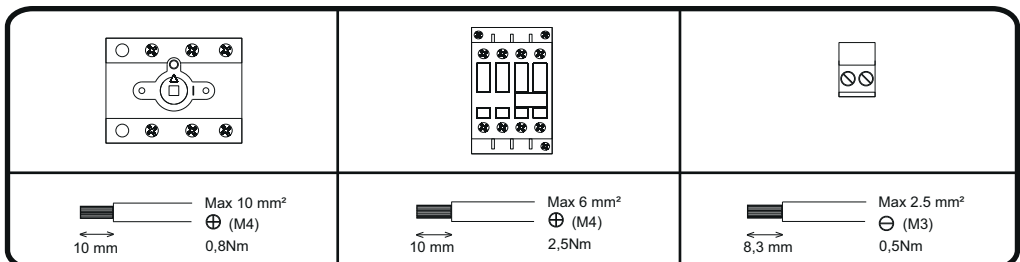

## 4. APPLICATION EXAMPLES

Below are some practical examples of applications that can be implemented with the **MULTI 2** control panel.

### PRESSURE BOOSTER

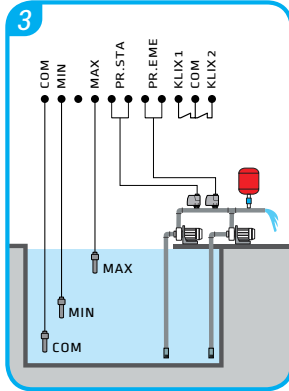



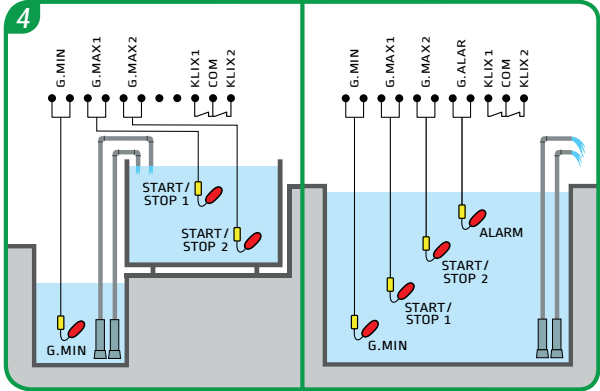

### CLEAN WATER

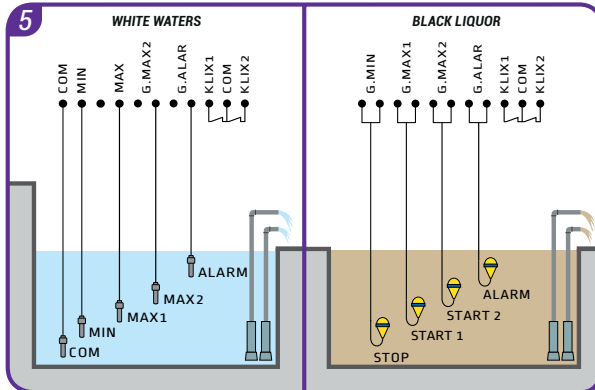

### SEWAGE



#### COMPONENTS KEY

-  Pressure switch
-  Float switch for clean water
-  Float switch for sewage
-  Level probe



### 5.1 DIP-SWITCH setting

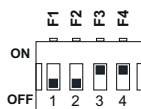

DEFAULT CONFIGURATION

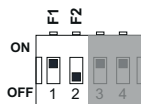
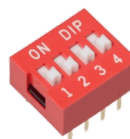

APPLICATION PRESSURE BOOSTER

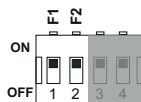

APPLICATION CLEAN WATER

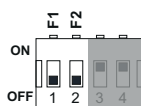

APPLICATION SEWAGE

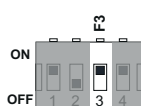

MOTORS' ALTERNANCE

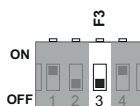

Active

Deactivates

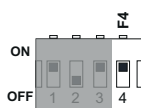

MINIMUM AND MAXIMUM VOLTAGE PROTECTION

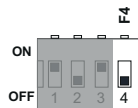

Active

Deactivates

The minimum and maximum voltage values are calibrated to a fixed value, on the single-phase version 185V and 255V while on the three-phase 345V and 440V.

### 5.2 Trimmer adjustments

#### SINGLE PHASE-VERSION

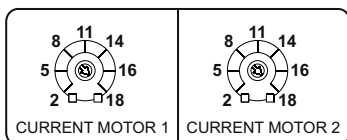

SA674.00

#### THREE-PHASE VERSION

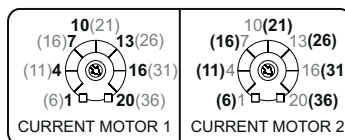

SA677.02

SA677.03  
SA677.04



Using the trimmer **CURRENT MOTOR 1** and **2**, it is possible to adjust the maximum motor overload current. To perform a good calibration it is advisable to rotate the trimmer up to the full scale value and then, when the motor is on, turn it counter-clockwise until the motor absorption current is detected (the red **PROTECTION** Led lights up) and then increase the regulation by 20%.

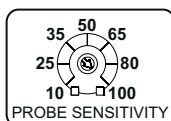

Through this trimmer it is possible to set the sensitivity of the conductivity between the level probes on the **G.MIN**, **G.MAX1**, **G.MAX2** and **ALL** inputs. The adjustment range is from 10 to 100 Kohm.

## 6. GENERAL FUNCTIONING OF THE CONTROL PANEL

### 6.1 General functioning

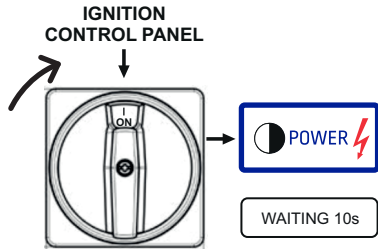

SUPPLY MAINS WAITING



THE MEASURED VOLTAGE VALUE IS OUT OF THE ALLOWED THRESHOLD



MISSING OR INCORRECT PHASE SEQUENCE



INDICATES THAT THE MOTORS 1 AND 2 ARE RUNNING



INDICATES THAT THE MOTORS 1 AND 2 ARE OFF



IT INDICATES A MOTOR OVERLOAD ALARM THAT CAUSES THE SHUTDOWN



INDICA UN ALLARME DI INTERVENTO DEL KLIXON DEI MOTORI CHE NE CAUSA LO SPEGNIMENTO



IT SERVES TO SILENCE THE SIREN OUTPUT IN PRESENCE OF ANY ALARM



**MANUAL OPERATION:** IT IS ACTIVATED FROM THE STOP STATUS BY HOLDING THE BUTTON PRESSED. IN THIS CONDITION THE CONTROL PANEL STARTS THE MOTOR UNTIL THE BUTTON IS RELEASED EXCLUDING THE CONTROL ON THE AUTOMATIC. RELEASING THE BUTTON YOU RETURN TO THE STOP STATUS



**AUTOMATIC OPERATION:** IT IS ACTIVATED FROM THE STOP STATUS BY PRESSING THE BUTTON. IN THIS CONDITION THE CONTROL PANEL WILL WORK ACCORDING TO THE SET APPLICATION.



**STOP OPERATION:** IN THIS CONDITION THE CONTROL PANEL DOES NOT START THE MOTORS.

**N.B.: ALL ALARMS ARE AUTOMATICALLY RESET WITH THE EXCEPTION OF THE MOTOR OVERCURRENT WHICH RESETS BY PRESSING THE BUTTON FOR 2s**

LED KEY

● Off

☀ On

◐ Flashing



Fast flashing  
<0,5s

## 6.2 Application pressure booster

### FUNCTION



START PRESSURE SWITCH ON, ONLY ONE MOTOR IS ENABLED



EMERGENCY PRESSURE SWITCH ON, BOTH MOTORS ARE ENABLED

### ALARM



NO WATER (UNCOVERED MINIMUM LEVEL), BOTH MOTORS ARE DISABLED



WAITING FILLING, BOTH MOTORS ARE ENABLED

**N.B.: THE MOTORS START ONLY IF THEY ARE IN AUTOMATIC OPERATION AND STOP WHEN THE FLOAT SWITCH (START OR EMERGENCY) OF THE RESPECTIVE MOTOR IS OFF**

## 6.3 Application clean water

### FUNCTION



MAX 1 FLOAT SWITCH ON, THE FIRST MOTOR IS ENABLED



MAX 2 FLOAT SWITCH ON, BOTH MOTORS ARE ENABLED

### ALARM



ALARM FLOAT SWITCH ON, BOTH MOTORS AND ALARM OUTPUTS ARE ENABLED (FLASHING LAMP, SIREN AND PURE CONTACT)

**N.B.: THE MOTORS START ONLY IF THEY ARE IN AUTOMATIC OPERATION AND STOP WHEN THE FLOAT SWITCH (MAX 1 OR MAX 2) OF THE RESPECTIVE MOTOR IS OFF**

## 6.4 Application sewage

### FUNCTION



MAX 1 FLOAT SWITCH ON, THE FIRST MOTOR IS ENABLED



MAX 2 FLOAT SWITCH ON, BOTH MOTORS ARE ENABLED

### ALARM



ALARM FLOAT SWITCH ON, BOTH MOTORS AND ALARM OUTPUTS ARE ENABLED (FLASHING LAMP, SIREN AND PURE CONTACT)

**N.B.: THE MOTORS START ONLY IF THEY ARE IN AUTOMATIC OPERATION, AND STOP ONLY WHEN THE MIN FLOAT SWITCH IS OFF**

## 7. TROUBLESHOOTING AND PROPOSED SOLUTIONS

FREQUENT PROBLEMS	CAUSES	OPERATION
No led on	No supply	Feed the plant respecting the input voltage
	General switch on 0	Set the switch on 1
	The cable inside the control panel is not connected	Connect properly the cable from the motherboard to the display
Maximum current alarm	Motor blocked or damaged	Disconnect the motor and be sure it is working properly
PRESSURE BOOSTER Mode: Led FUNCTION OFF low pressure in the tank	Possible failure of the pressure switches	Ceck the functionality of the pressure switches and replace if necessary
CLEAN WATER mode: FUNCTION led off with full tank	Possible failure of the float switches or connection cable interrupted	Ceck the functionality of the float switches and of the cable and replace if necessary
SEWAGE WATER mode: Led FUNCTION OFF high level of the water	Possible failure of the float switches or connection cable interrupted	Ceck the functionality of the float switches and of the cable and replace if necessary

## 8. SMALTIMENTO DI VECCHI APPARECCHI ELETTRICI ED ELETTRONICI DISPOSAL OF ELECTRICAL & ELECTRONIC EQUIPMENT

 Questo simbolo sul prodotto o sul suo imballo indica che esso non può essere trattato come rifiuto domestico. Al contrario, dovrà essere portato ad un punto di raccolta determinato per il riciclaggio degli apparecchi elettrici ed elettronici, come ad esempio:

- punti vendita, nel caso si acquisti un prodotto nuovo simile a quello da smaltire
- punti di raccolta locali (centri di raccolta rifiuti, centri locali di riciclaggio, ecc...).

AssicurandoVi che il prodotto sia smaltito correttamente, aiuterete a prevenire potenziali conseguenze negative per l'ambiente e la salute, che potrebbero essere causate da un inadeguato smaltimento di questo prodotto. Il riciclaggio dei materiali aiuterà a conservare le risorse naturali. Per informazioni più dettagliate riguardo il riciclaggio di questo prodotto, contattate per cortesia il Vs. ufficio locale, il Vs. servizio di smaltimento rifiuti domestici o il negozio dove avete acquistato questo prodotto.

 *This symbol on the product or its packaging indicates that it shall not be treated as household waste. Instead, it shall be handed over to the applicable collection point for the recycling of electrical and electronic equipment, such as for example:*

- sales points, in case you buy a new and similar product
- local collection points (waste collection centre, local recycling center etc...).

*By ensuring this product is disposed of correctly, you will help prevent potential negative consequence for the environment and human health, which could otherwise be caused by inappropriate waste handing of this product. The recycling of materials will help to preserve natural resources. For more detailed information about recycling of this product, please contact your local city office, your house hold waste disposal service or the shop where you purchased the product.*

## 9. DICHIARAZIONE DI CONFORMITA' DECLARATION OF CONFORMITY

ELETTROMEK di Germano' Antonino  
Via C. Colombo, 186  
98066 Patti (ME)

Dichiara che:

gli avviatori diretti **MULTI2** Monofase e Trifase

sono conformi ai requisiti di protezione in materia di sicurezza (bassa tensione) e di compatibilità elettromagnetica specifici previsti dalle Direttive della Comunità Europea 2006/95/CEE del 16 Gennaio 2007, 2004/108/CE del 10 Novembre 2007, 93/68/CEE del 22 Luglio 1993. Conformità CEI EN61439-1, EN 61000-6-3, EN 61000-6-1 DIN VDE 0113/EN60204-1 / IEC 204-1.

MANAGING DIRECTOR  
Germanò Antonio

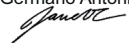

ELETTROMEK di Germano' Antonino  
Via C. Colombo, 186  
98066 Patti (ME)

Declares that:

the Single-phase and Three-phase **MULTI2** direct starters

comply with the specific protection prerequisites concerning both safety (low voltage) and the electromagnetic compatibility provided for by the European Community laws 2006/95/CEE of 16th January 2007, 2004/108/CE of 10th November 2007, 93/68/CEE of 22th July 1993. Compliance CEI EN61439-1, EN 61000-6-3, EN 61000-6-1 DIN VDE 0113/EN60204-1 / IEC 204-1.

MANAGING DIRECTOR  
Germanò Antonio

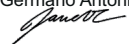







**ELETTROMEK**

Via C. Colombo, 186

98066 Patti (ME) ITALY

Tel.:+39 - (0) 941 - 361336

Fax:+39 - (0) 941 - 372806

**[www.xpowerwaterpumps.com](http://www.xpowerwaterpumps.com)**

e-mail: **[info@xpowerwaterpumps.com](mailto:info@xpowerwaterpumps.com)**

